

ALLIANCE

OUTDOOR LIGHTING

2020



bt does it all.

- Change Color Temperatures from Warm White to Cool White
- Dim
- Group
- Change RGB Colors
- Create Custom Scenes for Holidays and Events



available in: scan for app



App Store



iOS QR Code



Google play



Android QR Code

Follow the Leader

ALLIANCE

OUTDOOR LIGHTING

Since 2006



Which bt fixtures are available?

In addition to pages 3-9, look for this icon to indicate which products have a bt option available.

Visit our online video library to learn more about the BL200-BT.
www.doyouknowalliance.com



BL200-bt
bt Bullet Light

Fixture Features:

- Cast brass fixture, aged brass finish
- Cast brass knuckle with dial adjustment
- Fully adjustable brass shroud
- Clear glass convex lens
- Double wire lead pre-connected to the fixture, 16 awg (UL listed), brown
 - 25 foot wire lead, pre-stripped for easy wire connection
 - 18 inch wire lead, LED connection ready
- Plastic ground stake (8.5 in; 21.6 cm length)
- Ten year warranty

Integrated LED Features:

- Wattage: 4-8
- Operating Voltage Range: 10 -14
- Lumen Output: 15 - 350
- Beam Spread: 40°
- CRI: 80
- CCT Options: Preset options for 2700K, 3000K, 4000K
- RGB Options: Unlimited Color Wheel Options with quick preset options
- Dimming: Dimming option available for every color choice
- Scenes: Customizable scene options with up to 3 colors per scene

bt-RE

bt Range Extender

Fixture Features:

- Cast brass fixture, aged brass finish
- 5 db external antenna
- LED network indicator light
- 10 Foot wire lead, 16 awg (*UL listed*), brown, pre-connected to the fixture, pre-stripped for easy wire connection
- Plastic ground stake (*8.5 in; 21.6 cm length*)
- Ten year warranty



Install the bt-RE on every job.

Get Your Fixtures Talking!

The bt system uses Bluetooth Mesh technology to communicate. The mesh network becomes stronger with more devices in the same network. A distance gap between fixtures can cause a loss of communication. To ensure that all of your fixtures communicate with each other, install a bt Range Extender to each network on every job no matter how big or small.

**ALSTEM18-bt**

bt Area Light Stem

Fixture Features:

- 18" Brass stem, aged brass finish
- Brass collar
- Frosted Lens with rubber gasket
- Double wire lead pre-connected to the fixture, 16 awg (*UL listed*), brown
 - 25 foot wire lead, pre-stripped for easy wire connection
 - 18 inch wire lead, LED connection ready
- Plastic ground stake (*8.5 in; 21.6 cm length*)
- Ten year warranty on integrated fixture

**Note: Area light hats are sold separately*

• *Compatible with AL100, AL150, AL200, AL300, AL400, AL500, AL550 and AL600*

Integrated LED Features:

- Wattage: 4-8
- Operating Voltage Range: 10 -14
- Lumen Output: 15 - 150
- Beam Spread: 360°
- CRI: 80
- CCT Options: Preset options for 2700K, 3000K, 4000K
- RGB Options: Unlimited Color Wheel Options with quick preset options
- Dimming: Dimming option available for every color choice
- Scenes: Customizable scene options with up to 3 colors per scene

FL50-bt

bt Flood Light



Fixture Features:

- Cast brass fixture, aged brass finish
- Cast brass knuckle with dial adjustment
- Brass faceplate with rubber gasket
- Clear glass lens
- Double wire lead pre-connected to the fixture, 16 awg (*UL listed*), brown
 - 25 foot wire lead, pre-stripped for easy wire connection
 - 18 inch wire lead, LED connection ready
- Plastic ground stake (*8.5 in; 21.6 cm length*)
- Ten year warranty

Integrated LED Features:

- Wattage: 2-5
- Operating Voltage Range: 10 -14
- Lumen Output: 15 - 350
- Beam Spread: 120°
- CRI: 80
- CCT Options: Preset options for 2700K, 3000K, 4000K
- RGB Options: Unlimited Color Wheel Options with quick preset options
- Dimming: Dimming option available for every color choice
- Scenes: Customizable scene options with up to 3 colors per scene

Compact, versatile and powerful.

BL400-bt

bt Bullet Light



Fixture Features:

- Cast brass fixture, aged brass finish
- Cast brass knuckle with dial adjustment
- Fully adjustable brass shroud
- 25 Foot wire lead, 16 awg (*UL listed*), brown, pre-connected to the fixture, pre-stripped for easy wire connection
- Brass mounting bracket
- Ten year warranty on integrated fixture

Integrated LED Features:

- Wattage: 4-8
- Operating Voltage Range: 10 -14
- Lumen Output: 15 - 900
- Beam Spread: 40°
- CRI: 80
- CCT Options: Preset options for 2700K, 3000K, 4000K
- RGB Options: Unlimited Color Wheel Options with quick preset options
- Dimming: Dimming option available for every color choice
- Scenes: Customizable scene options with up to 3 colors per scene

Highest lumen output available.



DL200-bt

bt Down Light

Fixture Features:

- Cast brass fixture, aged brass finish
- Cast brass knuckle with dial adjustment
- Fully adjustable brass shroud
- 25 Foot wire lead, 16 awg (UL listed), brown, pre-connected to the fixture, pre-stripped for easy wire connection
- Brass mounting bracket
- Ten year warranty on integrated fixture

Integrated LED Features:

- Wattage: 4-8
- Operating Voltage Range: 10 -14
- Lumen Output: 15 - 350
- Beam Spread: 40°
- CRI: 80
- CCT Options: Preset options for 2700K, 3000K, 4000K
- RGB Options: Unlimited Color Wheel Options with quick preset options
- Dimming: Dimming option available for every color choice
- Scenes: Customizable scene options with up to 3 colors per scene

PL100-bt

bt Path Light



Fixture Features:

- Solid brass with an aged brass finish
- Solid brass with dual adjustments, brass thumb screw for vertical adjustments, brass stem nut for horizontal adjustments
- Industry First, double wire lead pre-connected to the fixture, 16 awg (UL listed), brown -25 foot wire lead, pre-stripped for easy wire connection -18 inch wire lead, LED connection ready
- Plastic ground stake, attached to the fixture (8.5 in; 21.6 cm length)
- Ten year warranty on integrated fixture

Integrated LED Features:

- Wattage: 4-8
- Operating Voltage Range: 10 -14
- Lumen Output: 15 - 200
- Beam Spread: 120°
- CRI: 80
- CCT Options: Preset options for 2700K, 3000K, 4000K
- RGB Options: Unlimited Color Wheel Options with quick preset options
- Dimming: Dimming option available for every color choice
- Scenes: Customizable scene options with up to 3 colors per scene



GL100-bt

Faceplate with shroud and convex glass lens



GL150-bt

Faceplate with convex glass lens



GL160-bt

Grated faceplate with glass lens



GL170-bt

Closed faceplate with opposing output



GL180-bt

Closed faceplate with 180° output



GL190-bt

Closed faceplate with 360° output

GL-bt

bt In-Ground Light

Faceplate Options:



Fixture Features:

- Cast brass fixture, aged brass finish
- Casted brass faceplate with 4 screws
- Clear glass lens with gasket
- Double wire lead pre-connected to the fixture, 16 awg (UL listed), brown
 - 25 foot wire lead, pre-stripped for easy wire connection
 - 18 inch wire lead, LED connection ready
- Plastic ground stake (8.5 in; 21.6 cm length)
- Ten year warranty

Integrated LED Features:

- Wattage: 2-5
- Operating Voltage Range: 10 -14
- Lumen Output: 15 - 350
- Beam Spread: 40°
- CRI: 80
- CCT Options: Preset options for 2700K, 3000K, 4000K
- RGB Options: Unlimited Color Wheel Options with quick preset options
- Dimming: Dimming option available for every color choice
- Scenes: Customizable scene options with up to 3 colors per scene

SL25-bt

bt Step Light

**SL35-bt**

bt Step Light

**SL50-bt**

bt Step Light



SL25-bt/SL35-bt Features:

- Brass fixture, aged brass finish
- Solid brass louvered face plate with frosted lens
- 25' Wire lead
- Ten Year warranty on integrated fixture

SL25-bt Integrated LED:

- Wattage: 1-4
- Operating Voltage Range: 10 -14
- Lumen Output: 15 - 350
- Beam Spread: 40°
- CRI: 80
- CCT Options: Preset options for 2700K, 3000K, 4000K
- RGB Options: Unlimited Color Wheel Options with quick preset options
- Dimming: Dimming option available for every color choice
- Scenes: Customizable scene options with up to 3 colors per scene
- *Louvered face plate greatly reduces lumen output

SL35-bt Integrated LED:

- Wattage: 1-4
- Operating Voltage Range: 10 -14
- Lumen Output: 15 - 350
- Beam Spread: 40°
- CRI: 80
- CCT Options: Preset options for 2700K, 3000K, 4000K
- RGB Options: Unlimited Color Wheel Options with quick preset options
- Dimming: Dimming option available for every color choice
- Scenes: Customizable scene options with up to 3 colors per scene
- *Louvered face plate greatly reduces lumen output

SL50 Features:

- Brass fixture, aged brass finish
- Ceramic bi-pin socket
- Frosted lens
- 25 Foot wire lead, 16 awg (UL listed), brown, pre-connected to the fixture, pre-stripped for easy wire connection
- Lifetime warranty on fixture housing

SL50-bt Integrated LED:

- Wattage: 1-3
- Operating Voltage Range: 10 -14
- Lumen Output: 15 - 350
- Beam Spread: 40°
- CRI: 80
- CCT Options: Preset options for 2700K, 3000K, 4000K
- RGB Options: Unlimited Color Wheel Options with quick preset options
- Dimming: Dimming option available for every color choice
- Scenes: Customizable scene options with up to 3 colors per scene

UL100-bt

bt Underwater Light



UL100 Features:

- Brass fixture, aged brass finish
- Solid brass fixture base
- Solid brass shroud with water tight, sealed clear lens
- Ceramic bi-pin socket
- 25 Foot External Antenna, attached to the base
- 25 Foot underwater wire lead, pre-connected to the fixture
- UL1838 Certified underwater landscape luminaire
- Ten year warranty on integrated fixture

Integrated LED Features:

- Wattage: 4-8
- Operating Voltage Range: 10 -14
- Lumen Output: 15 - 350
- Beam Spread: 40°
- CRI: 80
- CCT Options: Preset options for 2700K, 3000K, 4000K
- RGB Options: Unlimited Color Wheel Options with quick preset options
- Dimming: Dimming option available for every color choice
- Scenes: Customizable scene options with up to 3 colors per scene

Retrofit bt

PAR36-bt drop-in lamp available for existing PAR36 fixtures. Recommended only for fixtures with open faces such as the BL300 and WL200. Not recommended for grated fixtures.

**LPAR36-LED-bt**

bt Drop-In PAR36 LED

Wattage: 2-7 watts
 Operating Voltage Range: 12 -24
 Lumen Output: 280lm- 460lm
 Beam Spread: 45°
 CRI: >80
 CCT Options: Preset options for 2700K, 3000K, 4000K
 RGB Options: Unlimited Color Wheel Options with quick preset options
 Dimming: Dimming option available for every color choice
 Scenes: Customizable scene options with up to 3 colors per scene





it150
150 Watt Intelligent Transformer
Two Commons, Two 14V Taps
Suitable for Indoor or Outdoor use
DOE Compliant



it300
300 Watt Intelligent Transformer
Three Commons, Three 14V Taps
Suitable for Indoor or Outdoor use
DOE Compliant



Perfect Timer for Your Christmas Lights



Plug into 120v outlet

Plug 120v device into itimer

ITIMER
Astronomical Timer
120v Input
15 Amp Capacity
Suitable for Indoor or Outdoor use
DOE Compliant

Uses:
Retrofit traditional transformers
Holiday lighting and decor
Ponds and water features

connect

itTM
& forget

Features:
Bluetooth Enabled
Astronomical Timer
Phone App Driven
Lifetime Warranty
For LED Only
DOE Compliant

available in:



App Store



Google play

scan for app



Area Light Hat Features:

**Note: Area light stems are sold separately*

- Brass area light hat, aged brass finish
- Polycarbonate frosted lens
- Polycarbonate clear lens (except for AL700, AL750, AL800 and AL850)
- Rubber gaskets
- Adjustable brass collar with thumb screw (AL700, AL750, AL800 and AL850)
- Lifetime warranty

Area Light Stems Sold Separately:

- ALSTEM12 – 12" Stem
- ALSTEM18 – 18" Stem
- ALSTEM24 – 24" Stem
- ALSTEM60 – 60" Stem
- ALSTEMADJ – 18"-29" Stem



AL100



AL400



AL150



AL500

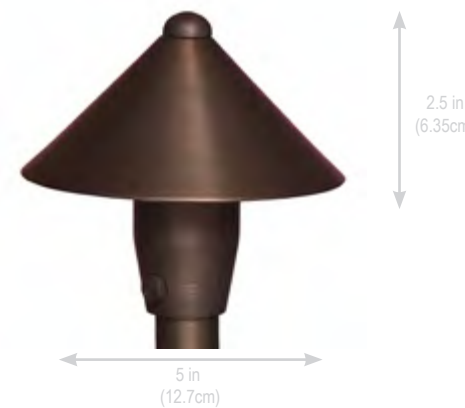

AL300



AL550



AL700



AL800



AL750



AL850



COMMERCIAL GRADE HATS

Features:

**Note: Area light stems are sold separately*

- Brass area light hat, aged brass finish
- Polycarbonate frosted lens
- Rubber gaskets
- Adjustable brass collar with thumb screw
- Lifetime warranty

Recommended Light Stems Sold Separately:

- ALSTEM18 – 18" Stem
- ALSTEM24 – 24" Stem
- ALSTEM60 – 60" Stem



TIKI Features:

**Note: Area light stems are sold separately*

- Brass area light hat, aged brass finish
- Metal snuffing cap with chain
- Wick with brass holder
- Solid brass collar
- Lifetime warranty

TIKI

Specialty Area Light Hat



PERMAPOST

Heavy Duty Ground Stake



ALSTEM60-LED

with PERMAPOST included
(LBIPIN-LED-200lm lamp included)

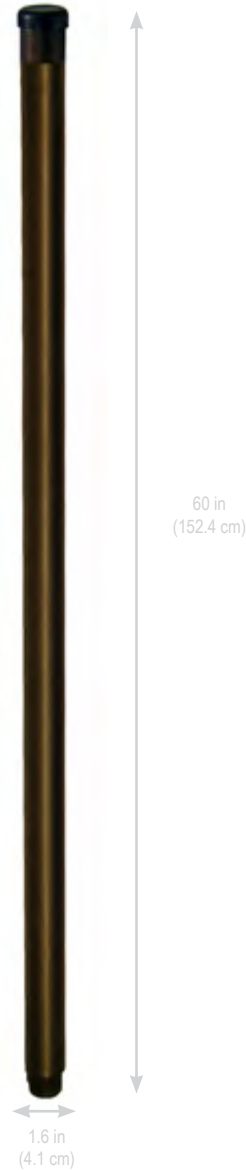

ALSTEM24-LED

(LBIPIN-LED-200lm lamp included)



ALSTEM18-LED

(LBIPIN-LED-200lm lamp included)



ALSTEM12-LED

(LBIPIN-LED-200lm lamp included)



Adjustable Collar:
If you need more light, thread the collar down, exposing the lamp and providing more light. Unthread the collar to reduce light or eliminate glare. Simply tighten the thumb screw to secure collar for desired spread of light.

ALSTEMADJ-LED

(LBIPIN-LED-200lm lamp included)



Area Light Stem Features:

**Note: Area light hats are sold separately*

- Brass stem, aged brass finish
- Adjustable brass collar with thumb screw (ALSTEM60 excluded)
- Ceramic bi-pin socket
- Double wire lead pre-connected to the fixture, 16 awg (UL listed), brown
 - 25 foot wire lead, pre-stripped for easy wire connection
 - 18 inch wire lead, LED connection ready
- Plastic ground stake (8.5 in; 21.6 cm length) (ALSTEM60 excluded)
- PermaPost ABS stake with brass cap on ALSTEM60
- Lifetime warranty on fixture housing
- Available without a lamp

PL100-LED

(LBIPIN-LED-200lm lamp included)

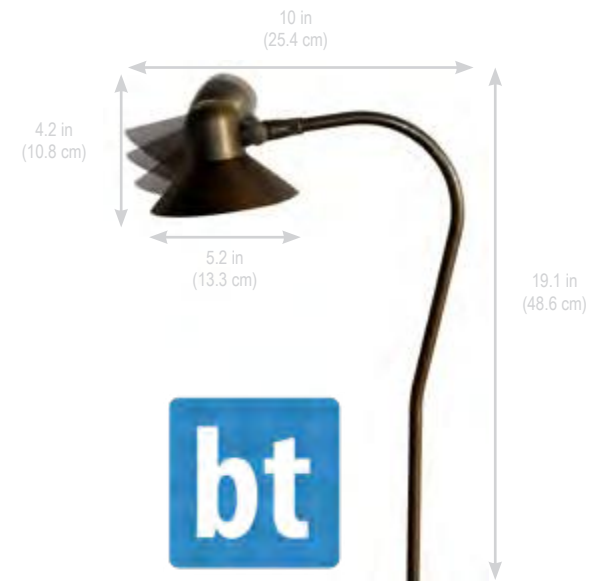

PL200-LED

(LBIPIN-LED-200lm lamp included)



PL250-LED

(LBIPIN-LED-200lm lamp included)



GOLF100-LED

(LBIPIN-LED-200lm lamp included)

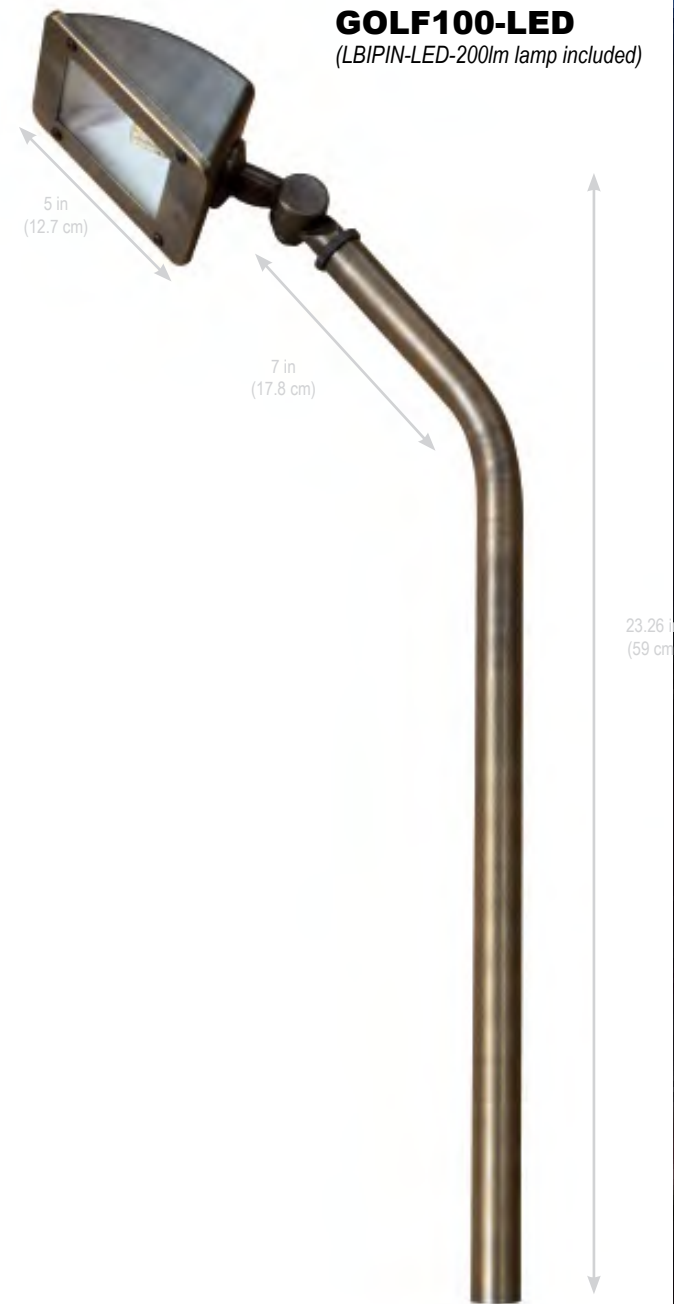

PL100-LED Features:

- Brass fixture, aged brass finish
- Solid brass hat with dual adjustments, brass thumb screw for vertical adjustments, brass stem nut for horizontal adjustments
- Ceramic bi-pin socket
- Frosted bubble lens
- Double wire lead pre-connected to the fixture, 16 awg (UL listed), brown
 - 25 foot wire lead, pre-stripped for easy wire connection
 - 18 inch wire lead, LED connection ready
- Plastic ground stake
- Lifetime warranty on fixture housing
- Available without a lamp

PL200-LED and PL250-LED Features:

- Solid brass area light hat
- Clear glass lens
- Adjustable brass stem, 17"-27" length, aged brass finish
- Ceramic bi-pin socket
- 25 Foot wire lead, 16 awg (UL listed), brown, pre-connected to the fixture, pre-stripped for easy wire connection
- Solid brass stake (8.5 in; 21.6 cm length)
- Lifetime warranty on fixture housing
- Available without a lamp

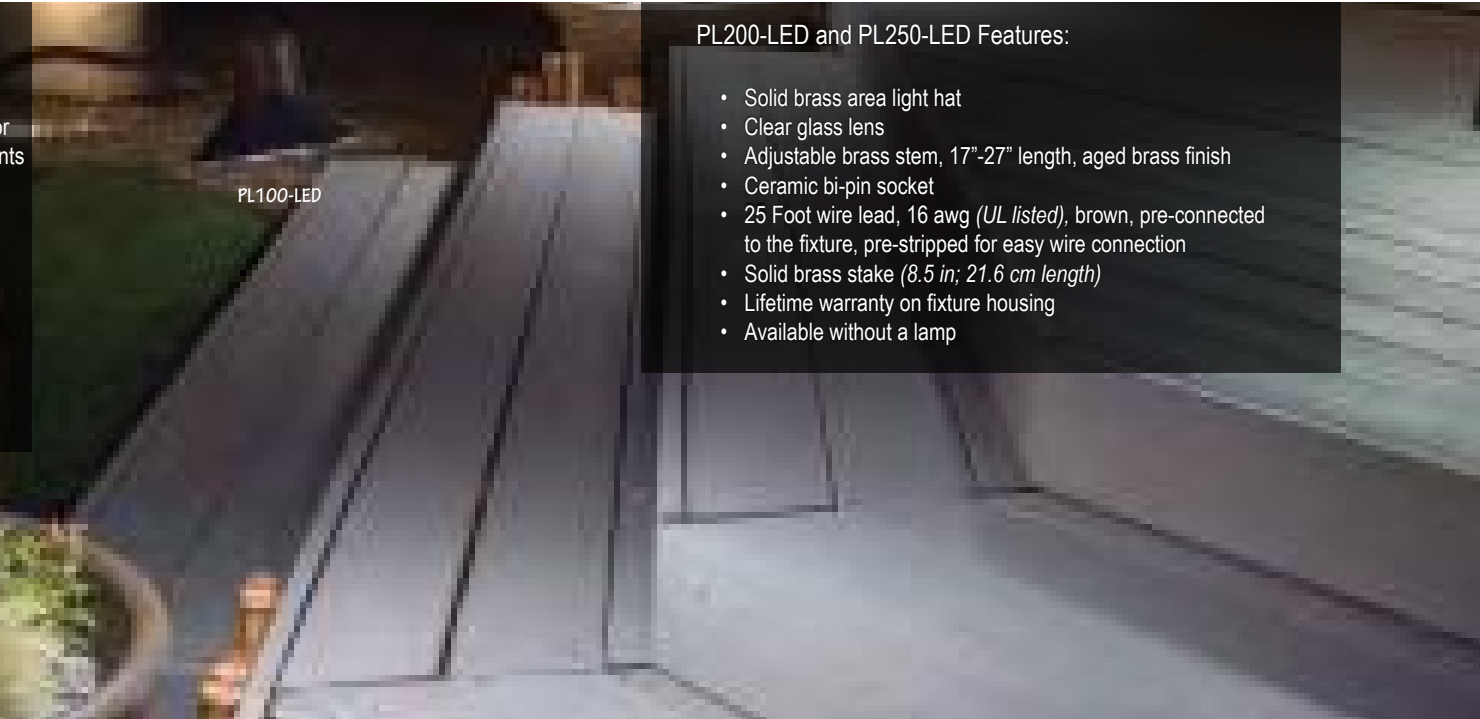

GOLF100 Feature:

- Brass riser with a 45° angle
- Brass fixture, aged brass finish
- Solid brass knuckle with dial adjustment
- Brass face plate with rubber gasket attached to fixture with 4 screws
- Clear lens
- Spring loaded ceramic bi-pin socket with dual contact
- 25 Foot wire lead, 16 awg (UL listed), brown, pre-connected to the fixture, pre-stripped for easy wire connection
- Plastic ground stake (8.5 in; 21.6 cm length)
- Lifetime warranty on fixture housing
- Available without a lamp



Photo Courtesy of: Danika Briggs Photography



Bullet Light Features:

- Cast brass fixture, aged brass finish
- Cast brass knuckle with dial adjustment
- Fully adjustable brass shroud
- Ceramic bi-pin socket with lamp clip (MR11 and MR16)
- Clear glass lens (BL300 excluded)
- Double wire lead pre-connected to the fixture, 16 awg (UL listed), brown
 - 25 foot wire lead, pre-stripped for easy wire connection
 - 18 inch wire lead, LED connection ready
- Plastic ground stake (8.5 in; 21.6 cm length) (CGBL01 comes with commercial grade brass stake collar)
- Lifetime warranty on fixture housing
- Available without a lamp

BL300-LED8W

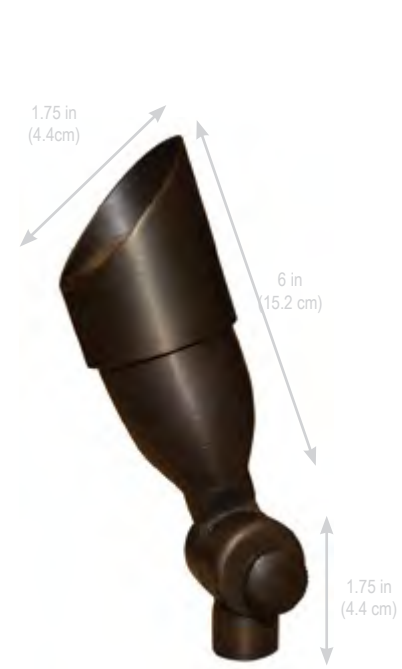

BL50-LED
(4 watt MR11 LED lamp included)

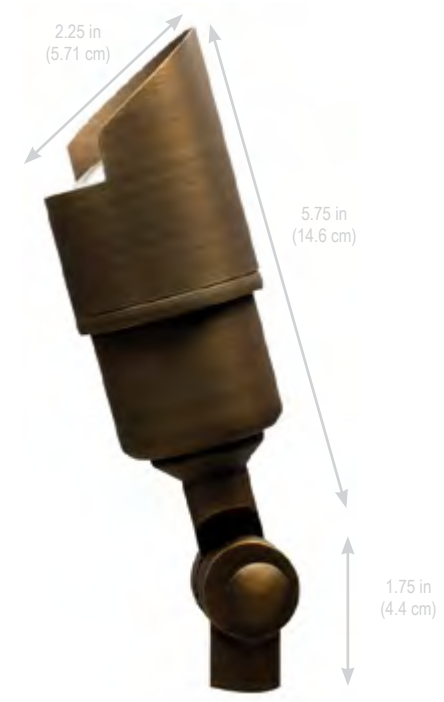

BL110-LED6W
(6 watt MR16 LED lamp included)

BL110-LED5W
(5 watt MR16 LED lamp included)

BL110-LED4W
(4 watt MR16 LED lamp included)

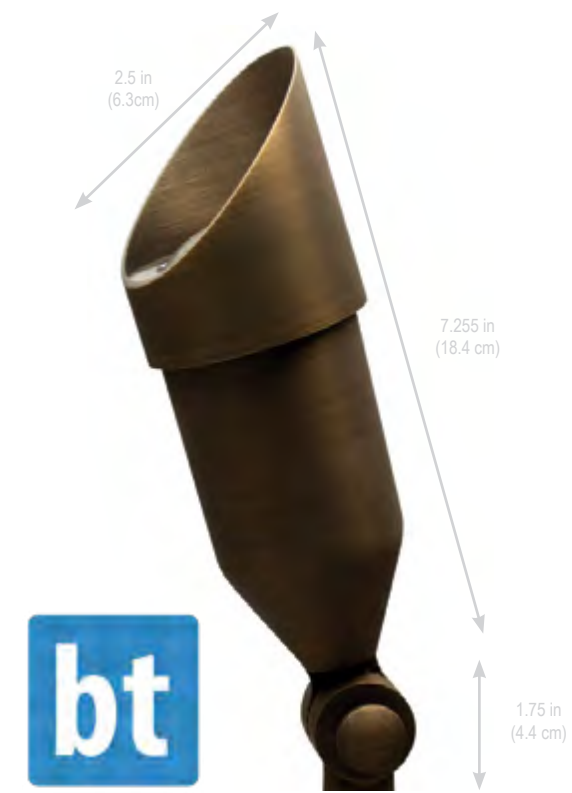

BL200-LED6W
(6 watt MR16 LED Lamp included)

BL200-LED5W
(5 watt MR16 LED Lamp included)

BL200-LED4W
(4 watt MR16 LED Lamp included)



BL300-LED10W
(10 watt PAR36 LED Lamp included)

BL300-LED8W
(8 watt PAR36 LED Lamp included)

BL300-LED4W
(4 watt PAR36 LED Lamp included)



BL900-LED6W
(6 watt MR16 LED Lamp included)

BL900-LED5W
(5 watt MR16 LED Lamp included)

BL900-LED4W
(4 watt MR16 LED Lamp included)



Hanging Light Features:

- Brass fixture, aged brass finish
- Cast brass base with ring
- Adjustable brass shroud on HL100
- Brass shroud with twinkle cutouts on HL200
- Ceramic bi-pin socket with lamp clip on HL100
- Ceramic bi-pin socket on HL200
- Threaded aged brass chain, 18" length
- 25 Foot wire lead, 16 awg (UL listed), brown, pre-connected to the fixture, pre-stripped for easy wire connection
- Lifetime warranty on fixture housing
- Available without a lamp

HL100-LED6W
(6 watt MR16 LED lamp included)

HL100-LED5W
(5 watt MR16 LED lamp included)

HL100-LED4W
(4 watt MR16 LED lamp included)



The shroud on the HL100 is easily extendable.

5.5 in
(14.0 cm)



Chain Length
18 in
(45.7 cm)

2.25 in
(5.7 cm)

HL200-LED
(LBIPIN-LED-200lm lamp included)

7.25 in
(18.4 cm)



Chain Length
18 in
(45.7 cm)

2.25 in
(5.7 cm)

DL50-LED
(4 watt MR11 LED lamp included)



5.75 in
(14.6 cm)

2.75 in
(7 cm)

1.75 in
(4.4 cm)

DL100-LED6W
(6 watt MR16 LED Lamp included)

DL100-LED5W
(5 watt MR16 LED Lamp included)

DL100-LED4W
(4 watt MR16 LED Lamp included)



4.5 in
(11.4 cm)

6.5 in
(16.5 cm)

3 in
(7.6 cm)

2.5 in
(6.4 cm)

DL200-LED6W
(6 watt MR16 LED Lamp included)

DL200-LED5W
(5 watt MR16 LED Lamp included)

DL200-LED4W
(4 watt MR16 LED Lamp included)



4.5 in
(11.4 cm)

8 in
(20.3 cm)

3 in
(7.6 cm)

2.5 in
(6.3 cm)



MR16 Down Light LED Lamps Now Come With Enclosed Housing

Down Light Features:

- Brass fixture, aged brass finish
- Solid brass knuckle with dial adjustment
- Brass shroud with rubber gasket
- Ceramic bi-pin socket with lamp clip
- 25 Foot wire lead, 16 awg (UL listed), brown, pre-connected to the fixture, pre-stripped for easy wire connection
- Solid brass mounting bracket, aged brass finish (DL100 and DL200)
- Brass mounting nut for precise adjustment (DL100 and DL200)
- Aged brass round mounting base (DL50)
- Mounting screws
- Lifetime warranty on fixture housing
- Available without a lamp

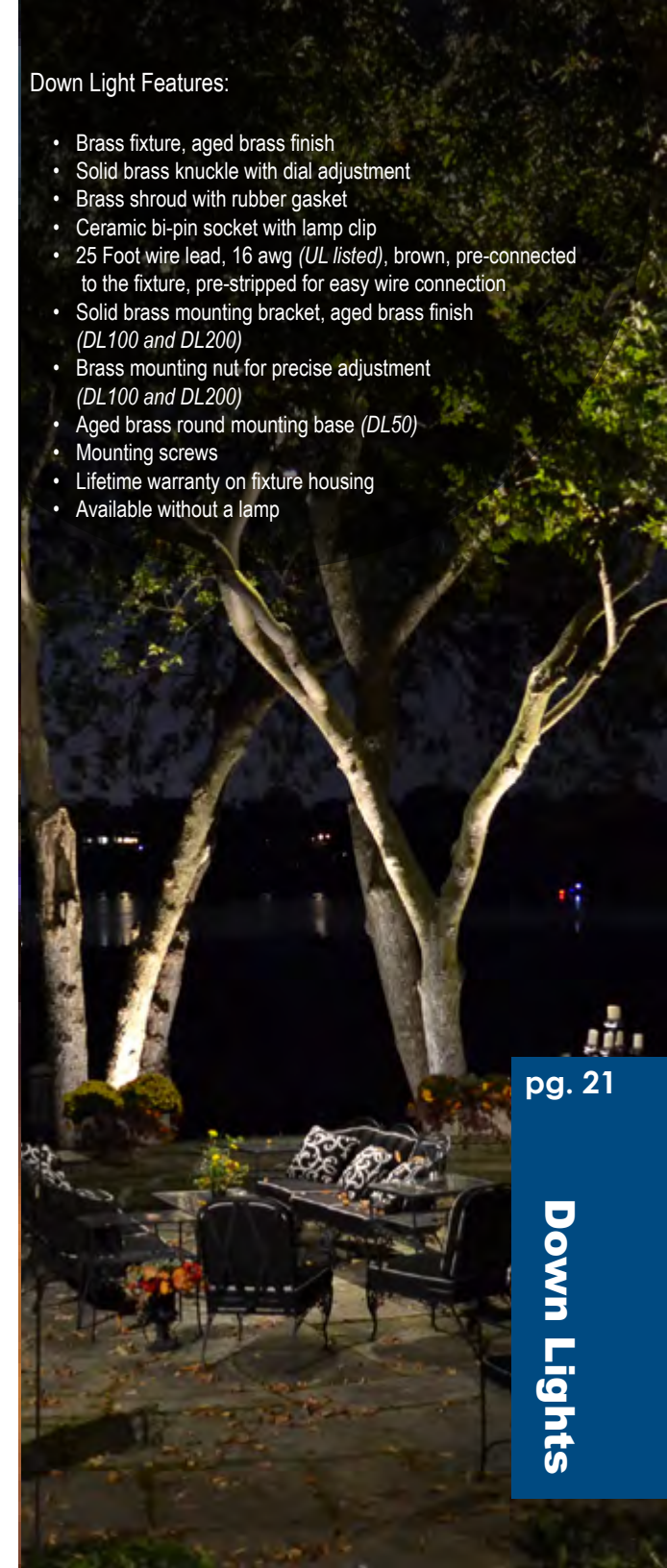

Flood Light Features:

- Brass fixture, aged brass finish
- Solid brass knuckle with dial adjustment
- Brass face plate with rubber gasket
- Ceramic bi-pin socket
- Clear lens (Optional frosted lens available)
- Double wire lead pre-connected to the fixture, 16 awg (UL listed), brown
 - 25 foot wire lead, pre-stripped for easy wire connection
 - 18 inch wire lead, LED connection ready
- Plastic ground stake (8.5 in; 21.6 cm length)
- Lifetime warranty on fixture housing
- Available without a lamp



FL50-LED
(LBIPIN-LED-200lm lamp included)



FL50-FFP
Frosted face plate sold separately



FL100-LED
(LBIPIN-LED-200lm lamp included)



FL100-FFP
Frosted face plate sold separately



FL200-LED6W
(6 watt MR16 LED lamp included)

FL200-LED5W
(5 watt MR16 LED lamp included)

FL200-LED4W
(4 watt MR16 LED lamp included)



FL50-LED

BL110-LED4W



FL50-LED

INDEX



- bt PRODUCTS.....2-9
- INTELLIGENT DEVICES10-11
- AREA LIGHTS12-15
- PATH LIGHTS.....16-17
- BULLET LIGHTS.....18-19
- DOWN LIGHTS.....20-21
- FLOOD LIGHTS.....22-23
- TABLE OF CONTENTS.....24-25
- IN -GROUND LIGHTS.....26-29
- STEP LIGHTS.....30-33
- UNDERWATER LIGHT.....35
- POST LIGHT.....36
- BOLLARD LIGHT.....37
- WALL SCONCE LIGHTS.....38
- DEMOKITS.....39
- TRANSFORMERS.....40-41
- ACCESSORIES.....42
- WARRANTY.....43
- LED LAMPS.....44
- ORDER FORM47

GL100-LED6W
(6 watt MR16 LED lamp included)



GL100-LED5W
(5 watt MR16 LED lamp included)

GL100-LED4W
(4 watt MR16 LED lamp included)

GL160-LED6W
(6 watt MR16 LED lamp included)



GL160-LED5W
(5 watt MR16 LED lamp included)

GL160-LED4W
(4 watt MR16 LED lamp included)

GL180-LED6W
(6 watt MR16 LED lamp included)



GL180-LED5W
(5 watt MR16 LED lamp included)

GL180-LED4W
(4 watt MR16 LED lamp included)

GL150-LED6W
(6 watt MR16 LED lamp included)



GL150-LED5W
(5 watt MR16 LED lamp included)

GL150-LED4W
(4 watt MR16 LED lamp included)

GL170-LED6W
(6 watt MR16 LED lamp included)



GL170-LED5W
(5 watt MR16 LED lamp included)

GL170-LED4W
(4 watt MR16 LED lamp included)

GL190-LED6W
(6 watt MR16 LED lamp included)



GL190-LED5W
(5 watt MR16 LED lamp included)

GL190-LED4W
(4 watt MR16 LED lamp included)



GL300-LED6W
(6 watt MR16 LED lamp included)

GL300-LED5W
(5 watt MR16 LED lamp included)

GL300-LED4W
(4 watt MR16 LED lamp included)



GL350-LED6W
(6 watt MR16 LED lamp included)

GL350-LED5W
(5 watt MR16 LED lamp included)

GL350-LED4W
(4 watt MR16 LED lamp included)

In-Ground Light Features:

- Brass fixture, aged brass finish
- Clear convex lens
- Solid brass fixture base
- Solid brass faceplate with four screws
- Ceramic bi-pin socket
- Double wire lead pre-connected to the fixture, 16 awg (UL listed), brown
 - 25 foot wire lead, pre-stripped for easy wire connection
 - 18 inch wire lead, LED connection ready
- Lifetime warranty on fixture housing
- Available without a lamp

Faceplate Options:



GL160



Grated Top

GL170



Opposing Sides Light Output

GL180



180° Light Output

GL190



360° Light Output

GL150-LED4W

BL50-LED

BL50-LED

GL150-LED4W

GL150-LED4W

GL300 Features:

- Solid brass faceplate with four screws
- Clear glass lens
- ABS fixture base with rubber gasket seal
- Ceramic bi-pin socket with adjustable swivel
- 5' wire lead, 16 awg (UL Listed), black, pre-connected to the fixture, pre-stripped for easy wire connection
- Lifetime warranty on fixture housing
- Available without a lamp

Faceplate Options:

GL360



Grated Top

GL370



Opposing Sides Light Output

GL380



180° Light Output

GL390



360° Light Output

BL50-LED

BL50-LED

GL150-LED4W

Photo Courtesy of: Joe Traina
Lighting Design by: Ryan Hughes Design



WL100-LED10W
(10 watt PAR36 LED lamp included)

WL100-LED8W
(8 watt PAR36 LED lamp included)

WL100-LED4W
(4 watt PAR36 LED lamp included)

*Available in LED ONLY



WL200-LED10W
(10 watt PAR36 LED lamp included)

WL200-LED8W
(8 watt PAR36 LED lamp included)

WL200-LED4W
(4 watt PAR36 LED lamp included)

*Available in LED ONLY



WL300-LED6W
(6 watt MR16 LED lamp included)

WL300-LED5W
(5 watt MR16 LED lamp included)

WL300-LED4W
(4 watt MR16 LED lamp included)



The height of the lamp housing in the WL300 is easily adjustable.

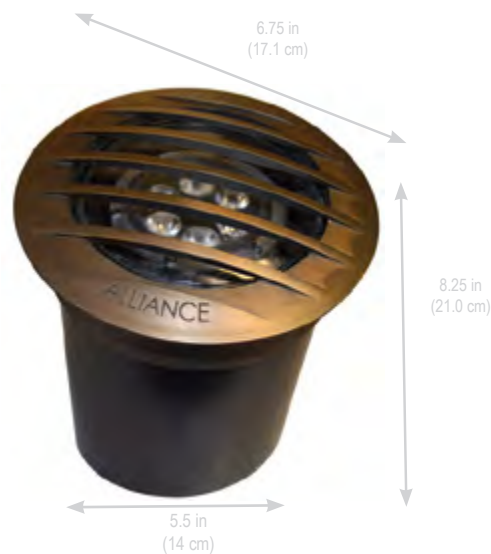

CGWL01-LED10W
(10 watt PAR36 LED lamp included)

CGWL01-LED8W
(8 watt PAR36 LED lamp included)

CGWL01-LED4W
(4 watt PAR36 LED lamp included)

*Available in LED ONLY

WL100 and WL200 Feature:

- ABS grate, black (WL100)
- Aged brass debris guard with clear glass lens (WL200)
- ABS housing, black
- Lamp retainer ring, stainless steel
- Double wire lead pre-connected to the fixture, 16 awg (UL listed), brown
 - 25 foot wire lead, pre-stripped for easy wire connection
 - 18 inch wire lead, LED connection ready
- Lifetime warranty on fixture housing

WL300 Features:

- Aged brass louvered grate with lamp holder
- Lamp height adjusting track with locking nuts
- ABS housing, black
- Ceramic bi-pin socket
- Double wire lead pre-connected to the fixture, 16 awg (UL listed), brown
 - 25 foot wire lead, pre-stripped for easy wire connection
 - 18 inch wire lead, LED connection ready
- Lifetime warranty on fixture housing
- Available without a lamp

CGWL01 Features:

- Heavy brass grate, aged brass finish
- Clear glass convex lens, tempered
- Lamp retainer ring, stainless steel
- ABS housing, black
- Double wire lead pre-connected to the fixture, 16 awg (UL listed), brown
 - 25 foot wire lead, pre-stripped for easy wire connection
 - 18 inch wire lead, LED connection ready
- Lifetime warranty on fixture housing



DL50-LED

TAPE-LED-15FT

TAPE-LED Features:

- 5 Foot LED strip
- Mounting clips included
- 10' wire lead, 16 awg (UL Listed), brown, pre-connected to the fixture, pre-stripped for easy wire connection
- 10 Year warranty on LED components and fixture housing

LED strip

- Beam Angle: 120°
- Beam Spread: Flood
- Color: Warm White
- Color Temperature: 2700K
- Operating Voltage: 10.8Vac - 15Vac
- CRI: Ra>80
- Rated Hours: 30,000
- Ambient Operating Temperature: -40°C ~ +85°C

TAPE-LED-5FT

Integrated LED Step Light
Can be cut down to length
LED strip, 5 Feet

- Watts: 5w
- Light Output: 350 lm (Lumens)

Per 1 Foot:

- Watts: 1w
- Light Output: 70 lm (Lumens)

TAPE-LED-15FT

Integrated LED Step Light
Can be cut down to length
LED strip, 15 Feet

- Watts: 15w
- Light Output: 1050 lm (Lumens)

Per 1 Foot:

- Watts: 1w
- Light Output: 70 lm (Lumens)

TAPE-LED-15FT-LL

Lower Lumen Output

- Watts: 8w
- Light Output: 675 lm (Lumens)

Per 1 Foot:

- Watts: .5w
- Light Output: 45 lm (Lumens)

TAPE-LED-30FT

Integrated LED Step Light
Can be cut down to length
LED strip, 30 Feet

- Watts: 30w
- Light Output: 2,100 lm (Lumens)

Per 1 Foot:

- Watts: 1w
- Light Output: 70 lm (Lumens)



Can be Cut Down to Size

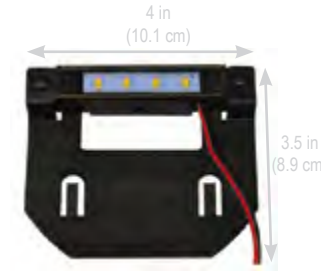

SL65-LED

Integrated LED Step Light
LED strip, 4 chips

- Watts: 2w
- Light Output: 110 lm (Lumens)



SL75-LED

Integrated LED Step Light
LED strip, 8 chips

- Watts: 3w
- Light Output: 300 lm (Lumens)

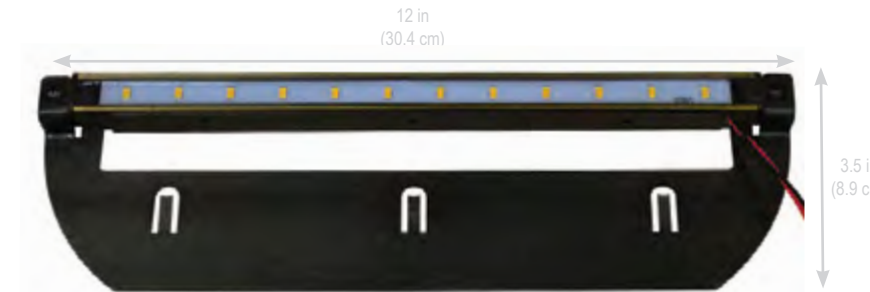

SL85-LED

Integrated LED Step Light
LED strip, 12 chips

- Watts: 4w
- Light Output: 380 lm (Lumens)



Mounting bracket is removable for further applications.
Optional frosted lens is included with the fixture.

MOST POPULAR

The 7" SL75-LED is our most popular and works in countless applications.

The 4" SL65-LED will work great on shorter walls and corners.

The 12" SL85-LED is ideal for taller walls and will provide a wider coverage area.

SL-LED Series Features:

- Brass fixture, aged brass finish
- Mounting bracket, stainless steel, aged brass finish
- Optional frosted lens included
- 10' wire lead, 16 awg (UL Listed), brown, pre-connected to the fixture, pre-stripped for easy wire connection
- 10 Year warranty on LED components and fixture housing
- Integrated LED strip
- Beam Angle: 120°
- Beam Spread: Flood
- Color: Warm White
- Color Temperature: 2700K
- Operating Voltage: 10.8Vac - 15Vac
- CRI: Ra>80
- Rated Hours: 30,000
- Ambient Operating Temperature: -40°C ~ +85°C

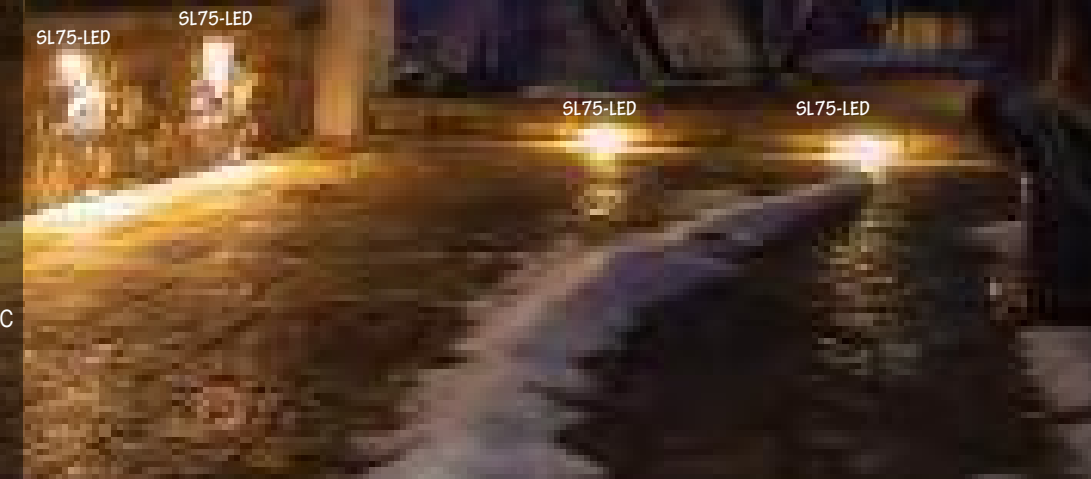

SL100-LED

SL50 Features:

- Brass fixture, aged brass finish
- Ceramic bi-pin socket
- Frosted lens
- 25 Foot wire lead, 16 awg (UL listed), brown, pre-connected to the fixture, pre-stripped for easy wire connection
- Lifetime warranty on fixture housing

SL50-LED
(LBIPIN-LED-200lm lamp included)

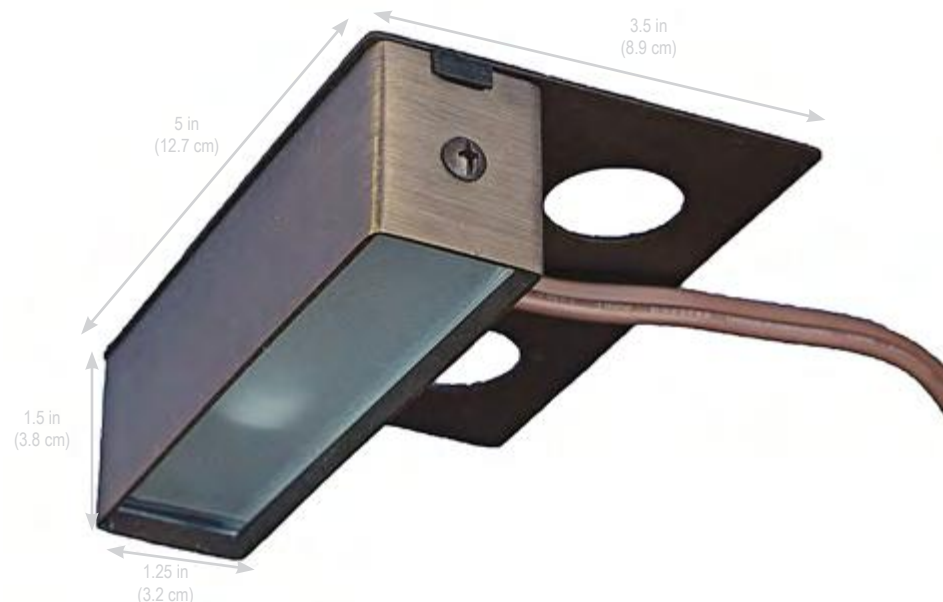

SL100-LED
(LBIPIN-LED-200lm lamp included)

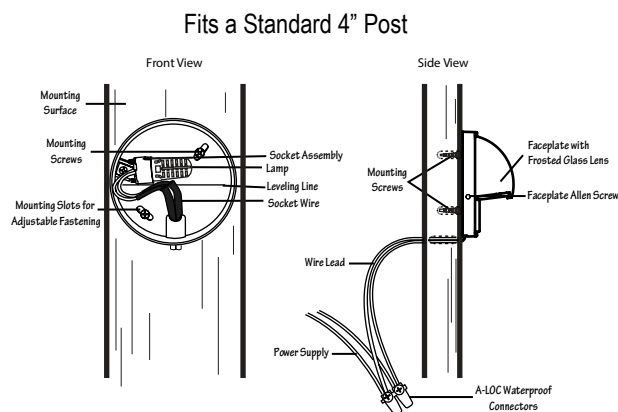

SL100 Features:

- Brass fixture, aged brass finish
- Solid brass face plate with securing hex screws
- Allen wrench tool to tighten hex screws
- Base plate with adjustable mounting guides
- Ceramic bi-pin socket
- Frosted lens
- 25 Foot wire lead, 16 awg (UL listed), brown, pre-connected to the fixture, pre-stripped for easy wire connection
- Mounting hardware screws
- Two extra adjusting hex face plate screws
- Mounting template
- Lifetime warranty on fixture housing
- Available without a lamp

SL25-LED
Integrated Surface Mount Step Light



Mounts directly onto desired surface
(Back View)



(Side View)

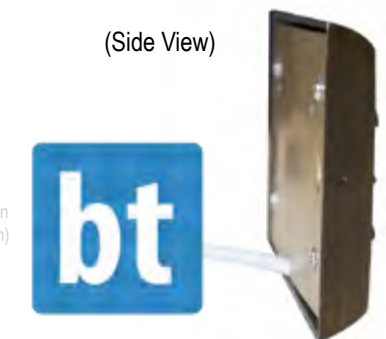

SL35-LED
Integrated Surface Mount Step Light



SL200 and SL300 Features:

- Brass fixture, aged brass finish
- Solid brass face plate with securing screws
- Ceramic bi-pin socket
- 25 Foot wire lead, 16 awg (UL listed), brown, pre-connected to the fixture, pre-stripped for easy wire connection
- Optional metal set box included
- Lifetime warranty on fixture housing
- Available without a lamp

(Back View)



(Side View)



SL200-LED
(LBIPIN-LED-200lm lamp included)

SL300-LED
(Two LBIPIN-LED-200lm lamps included)

SL25-LED/SL35-LED Features:

- Brass fixture, aged brass finish
- Solid brass louvered face plate with frosted lens
- 25' Wire lead
- 10 Year warranty on LED components and fixture housing

SL25-LED Integrated LED:

- Watts: 7w
- Lumens: 570lm*
- Color: Warm White
- Color Temperature: 2700K
- Operating Voltage: 8Vac-15Vac
- CRI: Ra>80
- Rated Hours: 30,000 Hours
- Ambient Operating Temperature: -40°C ~ +85°C

SL35-LED Integrated LED:

- Watts: 13w
- Lumens: 1,000lm*
- Color: Warm White
- Color Temperature: 2700K
- Operating Voltage: 8Vac-15Vac
- CRI: Ra>80
- Rated Hours: 30,000 Hours
- Ambient Operating Temperature: -40°C ~ +85°C

*Louvered face plate greatly reduces lumen output

SL25-LED

SL25-LED

SL25-LED



UL100-LED6W
(6 watt MR16 LED lamp included)

UL100-LED5W
(5 watt MR16 LED lamp included)

UL100-LED4W
(4 watt MR16 LED lamp included)



UL100-LED5W

UL100 Features:

- Brass fixture, aged brass finish
- Solid brass fixture base
- Solid brass shroud with water tight, sealed clear lens
- Ceramic bi-pin socket
- 25 Foot underwater wire lead, pre-connected to the fixture (also available with 50 Foot and 100 Foot wire leads)
- UL1838 Certified underwater landscape luminaire
- Lifetime warranty on fixture housing
- Available without a lamp



POST100-LED6W

(6 watt MR16 LED lamps included)

POST100-LED5W

(5 watt MR16 LED lamps included)

POST100-LED4W

(4 watt MR16 LED lamps included)



Post Light Features:

- Brass post light, aged brass finish
- Frosted lens panels
- Ceramic bi-pin socket
- Mounting hardware
- 25 foot wire lead, 16 awg(UL Listed), brown, pre-connected to the fixture, pre-stripped for easy wire connection
- Lifetime warranty on fixture housing
- Available without a lamp



BOLLARD100-LED

(LBIPIN-LED-200lm lamp included)



Bollard Features:

- Solid brass three-tiered cover, aged brass finish
- Aluminum post, aged brass finish
- Clear and frosted polycarbonate lens with gaskets
- Ceramic bi-pin socket
- Aluminum mounting base with hardware
- 36 inch wire lead, 16 awg(UL Listed), brown, pre-connected to the fixture, pre-stripped for easy wire connection
- Plastic ground stake (8.5 in; 21.6 cm length) (optional)
- Lifetime warranty on fixture housing
- Available without a lamp

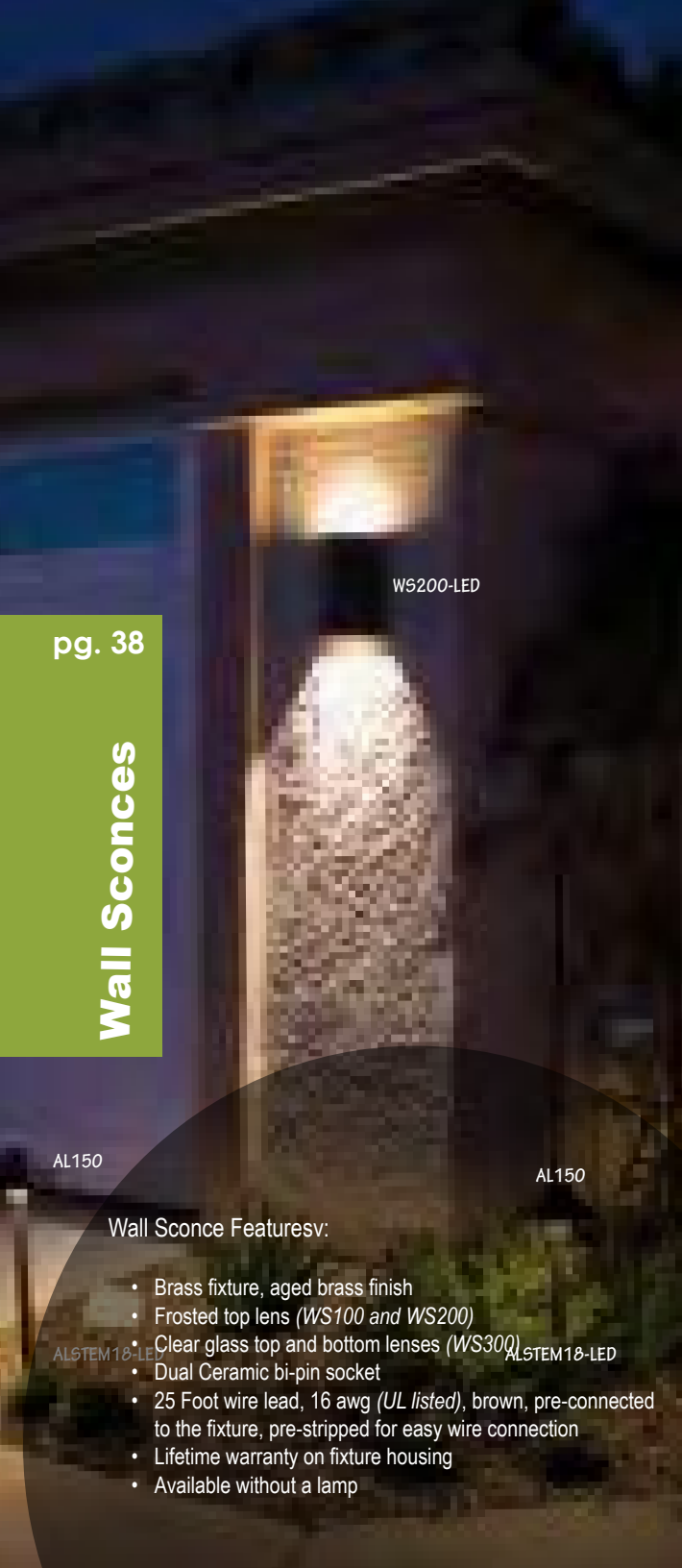

WS200-LED

AL150

AL150

Wall Sconce Features:

- Brass fixture, aged brass finish
- Frosted top lens (WS100 and WS200)
- Clear glass top and bottom lenses (WS300)
- Dual Ceramic bi-pin socket
- 25 Foot wire lead, 16 awg (UL listed), brown, pre-connected to the fixture, pre-stripped for easy wire connection
- Lifetime warranty on fixture housing
- Available without a lamp



WS100-LED
(Two LBIPIN-LED-200lm lamps included)



WS200-LED
(Two LBIPIN-LED-200lm lamps included)



WS300-LED6W
(Two 6 watt MR16 LED lamps included)

WS300-LED5W
(Two 5 watt MR16 LED lamps included)

WS300-LED4W
(Two 4 watt MR16 LED lamps included)

DEMOKIT8-bt
(bt Demonstration Kit)

DEMOKIT8
(LED Demonstration Kit)



Quick connects on every wire lead,
for an easy and fast connection

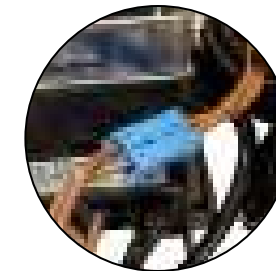

DEMOKIT8-bt Includes:



- (6) BL200-bt
- (2) ALSTEM18-bt
- (1) bt-RE
- (1) TF150 Transformer
- (2) Wire Splitters
- (12) Extra Connectors
- Storage Locker

DEMOKIT8 Includes:

- (6) BL200-LED4W
- (2) ALSTEM12-LED
- (2) AL100 Area Light Hats
- (1) TF150 Transformer
- (2) Wire Splitters
- (12) Extra Connectors
- Storage Locker

Demo Kit Features:

- Our industry first double wire leads: fixtures with two 16 awg (UL Listed) brown wire leads pre-connected to the fixture, one 18" and one 25' in length.
- Quick connecting adapters at each wire end making connections fast and easy (not intended for in ground burial)
- A TF150 transformer with an 18" wire lead pre-connected with quick connect adapter
- A compact storage locker making the kit easy to store and transport
- Extra quick connectors
- Door Hangers



it150
150 Watt Intelligent Transformer
Two Commons, Two 14V Taps

it300
300 Watt Intelligent Transformer
Three Commons, Three 14V Taps

Features:
Bluetooth Ready
Phone App Driven
Multiple 14.0v Taps
Astronomical Timer
Lifetime Warranty
FOR LED ONLY
DOE Compliant

Dimensions:
L10.875" x W5.125" x H5.25"

TF300

300 Watt Stainless Steel Transformer Featuring:
- Multiple Taps (12v-15v)
- Built in photocell/timer
- DOE Compliant



TF200

200 Watt Stainless Steel Transformer Featuring:
- One 12 Volt tap only
- Built in photocell/timer
- DOE Compliant



TF150

150 Watt Transformer Featuring:
- One 12 Volt tap only
- Built in photocell/timer
- DOE Compliant



ETF60

60 Watt Electronic Transformer



(XF150 pictured)

XF150

150 watt Transformer
COM1 COM2 12 13 14 15
Dimensions:
L14.37" x W4.72" x H5.12"

XF300

300 watt Transformer
COM1 COM2 12 13 14 15
Dimensions:
L15.98" x W7.28" x H5.12"

XF600

600 watt Transformer
COM1 12 13 14 15 16 17 18 COM2
Dimensions:
L15.98" x W7.28" x H5.12"

XF TRANSFORMER ACCESSORIES

PC
Photocell



3.5 in
(7.6 cm)

TIMER
Mechanical Timer



Depth:
1.5 in
(3.8 cm)

CONNECTION ACCESSORIES

A-LOC
Waterproof Wire Connectors



CS150
Two Brass Connectors and Plastic Lug Caps



CS100
Two Brass Connectors with Set Screws and Plastic Lug Caps in PVC housing



2.5 in
(6.4 cm)

9.25 in
(23.5 cm)

RMB
Aged Brass Round Mounting Base



GUTTERMOUNT
Aged Brass Gutter Mount

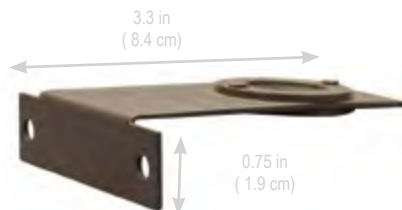

RISERADJ-BRASS
Adjustable Brass Riser



RISER18
18" Aged Brass Riser

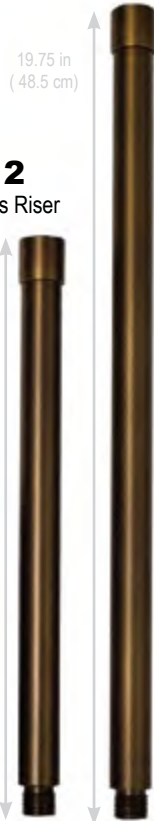

RISER12
12" Aged Brass Riser



RISER6
6" Aged Brass Riser

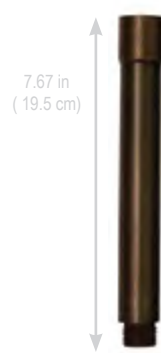

PERMAPOST
Heavy Duty Ground Stake



PRODUCT WARRANTY:

Alliance Outdoor Lighting warrants its products against defects in material and workmanship. Without charge, Alliance Outdoor Lighting will either repair or replace (Alliance Outdoor Lighting reserves the right to decide between repair or replacement) any properly installed Alliance Outdoor Lighting product that fails under normal operating conditions within the specified warranty period. Damage due to acts of nature, such as, but not limited to, lightning, flooding, explosions and earthquakes, are not covered.

- **Brass and Copper fixtures:** All have a lifetime warranty for all castings and housings.
- **XF Series Transformers:** All XF series transformers carry a lifetime warranty on enclosures. All transformer windings carry a lifetime warranty.
- **TF Series Transformers:** Two year warranty.
- **Integrated LED fixtures:** All Alliance LED integrated fixtures carry a 10 year warranty.
- **LED Lamps:** Ten year warranty.
- **Halogen Lamps:** Do not carry a warranty.
- **Timers and Photocells:** Do not carry a warranty.
- **ETF60 Transformers:** Do not carry a warranty.

All products are warranted from the date of invoice, provided it is returned to the Alliance Outdoor Lighting distributor from where it is purchased. Our factory inspection determines it to be defective under the terms of the warranty. This warranty covers only equipment manufactured by Alliance Outdoor Lighting and does not extend to transportation, installation, labor compensation, or replacement charges, nor does it apply to any equipment of another manufacturer used in conjunction with Alliance Outdoor Lighting equipment.

NOTE: All Alliance Outdoor Lighting products are designed to be repaired in the field by a qualified lighting installer. All service parts are readily available and we encourage field repairs as a significant cost and labor savings which can be realized by the installer. All warranted components, as stated in the above warranty, which are installed in the field, will be honored.



LBIPIN-LED-200lm

2.5 watt bipin, 200 lumens
IP67 certified



LBIPIN-LED-250lm

3 watt bipin, 250 lumens
IP67 certified

L3156-LED-200lm

2.5 watt 3156 wedge base, 200 lumens
IP67 certified



L3156-LED-250lm

3 watt 3156 wedge base, 250 lumens
IP67 certified



LBA15S-LED-200lm

2.5 watt single bayonet, 200 lumens
IP67 certified



LBA15D-LED-200lm

2.5 watt double bayonet, 200 lumens
IP67 certified



L921T5-LED-200lm

2.5 watt T5 wedge base, 200 lumens
IP67 certified

IP67: Lamps are dust tight and can be submerged in up to one meter of water



LPAR36-LED-4W-F

4 watt PAR36, 250 lumens, 20 degree



LPAR36-LED-4W-WF

4 watt PAR36, 250 lumens, 40 degree
(20 watt PAR36 equivalent)



LPAR36-LED-8W-F

8 watt PAR36, 300 lumens, 20 degree



LPAR36-LED-8W-WF

8 watt PAR36, 300 lumens, 40 degree
(35 watt PAR36 equivalent)



LPAR36-LED-10W-F

10 watt PAR36, 400 lumens, 30 degree

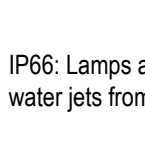

LPAR36-LED-10W-WF

10 watt PAR36, 400 lumens, 45 degree
(50 watt PAR36 equivalent)



LMR11-LED-4W-F

4 watt MR11, 175 lumens
Flood, 45 degree
(20 watt MR11 equivalent)



LMR16-LED-4W-F

4 watt MR16, 250 lumens
Flood, 45 degree
(20 watt MR16 equivalent)



LMR16-LED-4W-2700K

2700K Color Temperature

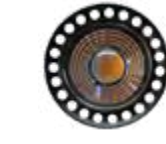

LMR16-LED-4W-WF

Wide Flood, 60 degree



LMR16-LED-4W-NS

Narrow Spot, 15 degree



LMR16-LED-250lm

Enclosed Housing
Recommended for Down Light Series



LMR16-LED-5W-F

5 watt MR16, 310 lumens
Flood, 45 degree
(35 watt MR16 equivalent)



LMR16-LED-5W-2700K

2700K Color Temperature



LMR16-LED-5W-WF

Wide Flood, 60 degree



LMR16-LED-5W-NS

Narrow Spot, 15 degree

LMR16-LED-310lm

Enclosed Housing
Recommended for Down Light Series

LMR16-LED-6W-F

6 watt MR16, 410 lumens
Flood, 45 degree
(50 watt MR16 equivalent)

LMR16-LED-6W-2700K

2700K Color Temperature



1ST INDUSTRY DOUBLE WIRE LEAD



We Provide the Wire
You Save on Labor

Connect the **Long 25'** Lead to the **Short 18"** Lead

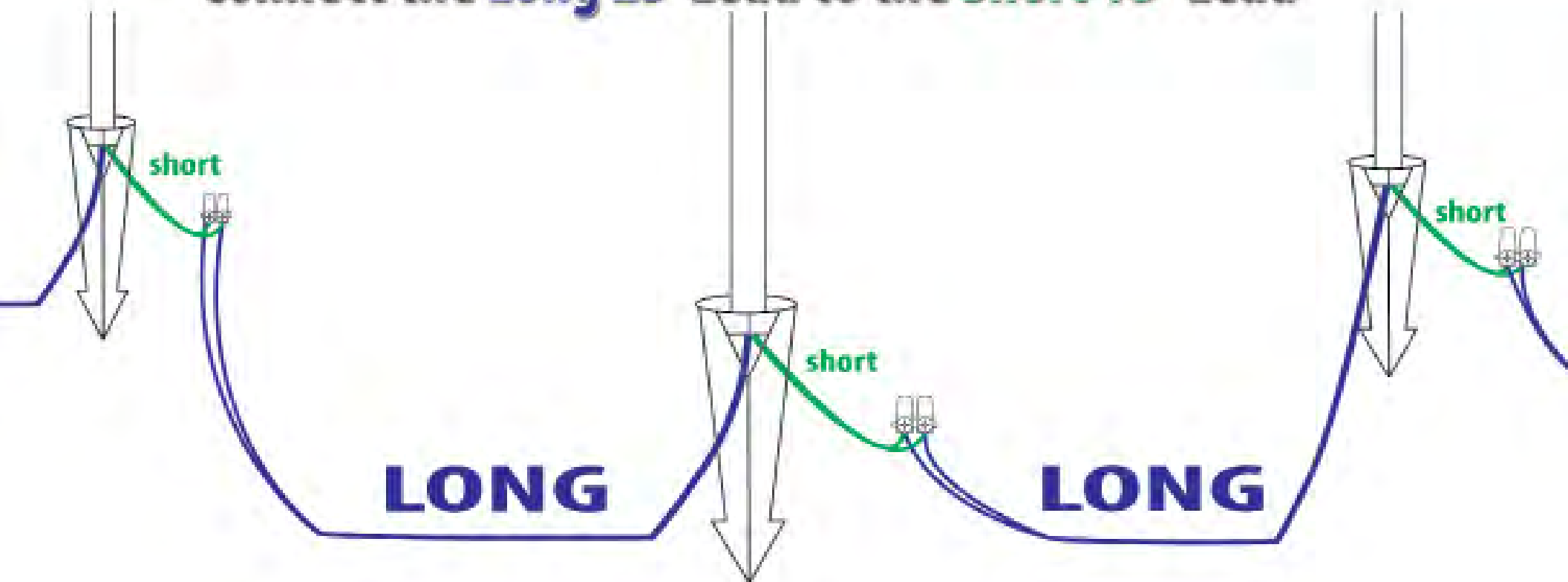

For LED installations only

bt Products	
Part #	Qty
Fixtures	
BL200-bt	
BL400-bt	
ALSTEM18-bt	
PL100-bt	
FL50-bt	
DL200-bt	
UL100-bt	
GL100-bt	
GL150-bt	
GL160-bt	
GL170-bt	
GL180-bt	
GL190-bt	
SL50-bt	
SL25-bt	
SL35-bt	

Accessories	
bt-RE	

Lamps	
LPAR36-bt	

Fixtures							
Part #		Qty		Part #		Qty	
AREA LIGHT HATS		DOWN LIGHTS		PATH LIGHTS			
AL100		DL50		PL100			
AL150		DL100		PL200			
AL300		DL200		PL250			
AL400		HL100		GOLF100			
AL500		HL200		WALL SCONCES			
AL550		IN-GROUND LIGHTS		WS100			
AL700		GL100		WS200			
AL750		GL150		WS300			
AL800		GL160		UNDERWATER LIGHT			
AL850		GL170		UL100			
TIKI		GL180		POST LIGHT			
AREA LIGHT STEMS		GL190		POST100			
ALSTEM12		GL300		TAPE LIGHT			
ALSTEM18		GL350		TAPE-LED-5FT			
ALSTEM24		GL360		TAPE-LED-15FT			
ALSTEM60		GL370		TAPE-LED-15FT-LL			
ALSTEMADJ		GL380		TAPE-LED-30FT			
BULLET LIGHTS		GL390		BOLLARD			
BL50		WL100-LED		BOLLARD100			
BL110		WL200-LED		Accessories			
BL200		WL300		GUTTERMOUNT			
BL300-LED		CGWL01-LED		RISER6			
BL900		STEP LIGHTS		RISER12			
FLOOD LIGHTS		SL25-LED		RISER18			
FL50		SL35-LED		RISERADJ-BRASS			
FL100		SL65-LED		RMB			
FL200		SL75-LED		PERMAPOST			
		SL85-LED					
		SL50					
		SL100					

LED Lamps		
Part #	Qty	
MR11		
LMR11-LED-4W-F		
MR16		
LMR16-LED-4W-F		
LMR16-LED-4W-F-2700K		
LMR16-LED-4W-NS		
LMR16-LED-4W-WF		
LMR16-LED-4W-250lm		
LMR16-LED-5W-F		
LMR16-LED-5W-F-2700K		
LMR16-LED-5W-NS		
LMR16-LED-5W-WF		
LMR16-LED-310lm		
LMR16-LED-6W-F		
LMR16-LED-6W-F-2700K		
PAR36		
LPAR36-LED4W-F		
LPAR36-LED4W-WF		
LPAR36-LED8W-F		
LPAR36-LED8W-WF		
LPAR36-LED10W-F		
LPAR36-LED10W-WF		
BIPIN/G4		
LBIPIN-LED-200lm		
LBIPIN-LED-250lm		

Transformers		
Part #	Qty	
IT SERIES		
IT150		
IT300		
XF SERIES		
XF150		
XF300		
XF600		
TF SERIES		
TF150		
TF200		
TF300		

Accessories		
A-LOC		
CS100		
CS150		
ETF60		
PC		
TIMER		
ITIMER		

ALLIANCE
OUTDOOR LIGHTING

Headquarters: Temecula, CA
Warehouses: Temecula, CA and Sanford, FL
Factory: Shenzhen, China

www.allianceoutdoorlighting.com